

W72RS Series

MINIMAL SPILL DOUBLE SEAT MIX PROOF VALVES



Engineering excellence, allied to stringent quality control, ensures that SPX FLOW's unrivalled range of WCB products complies with the highest international standards for hygiene. In the light of growing pressure worldwide to deliver safe, high quality food, all SPX FLOW products are designed for easy cleanability, while minimizing the use of valuable resources, such as energy.

The WCB product portfolio includes a wide range of pumps, valves, heat exchangers, mixers and homogenizers designed for use in the food, dairy and brewing industries, as well as in chemical, healthcare, pharmaceutical processing and heavy industries.

SPX FLOW, Inc. (NYSE:FLOW) is a leading manufacturer of innovative flow technologies, many of which help define the industry standard in the market segments they serve. From its headquarters in Charlotte, North Carolina, it operates a sales and support network, centers of manufacturing excellence, and advanced engineering facilities, throughout the world. Its cutting-edge flow components and process equipment portfolio includes a wide range of pumps, valves, heat exchangers, mixers, homogenizers, separators, filters, UHT, and drying technology that meet many application needs. Its expert engineering capability also makes it a premium supplier of customized solutions and complete, turn-key packages to meet the most exacting of installation demands.

Incorporating many leading brands, SPX FLOW has a long history of serving the food and beverage, power and energy, and industrial market sectors. Its designs and engineered solutions help customers drive efficiency and productivity, increase quality and reliability, and meet the latest regulatory demands. In-depth understanding of applications and processes, state-of-the-art Innovation Centers, and advanced pilot/testing technology further assist in optimizing processes and reducing timescales to reliably meet production targets.

To learn more about SPX FLOW capabilities, its latest technology innovations and complete service offerings, please visit www.spxflow.com.

W72RS Series Mix Proof Valves

Mix Proof valves provide safe separation of dissimilar products within the same valve body. The W72RS Series features a radial seal seat design for minimal spillage of products when opening and closing.

FEATURES AND BENEFITS

Safe, Continuous Production and Cleaning:

- Proven mix proof valve design allows plants to maximize production and minimize downtime for cleaning
- Radial seal (RS) design on lower stem minimizes spillage of product to drain during opening and closing for critical product applications in highly sanitary environments
- Full mix proof model portfolio for completely automated systems:
 - W72RS shut-off for safe separation in the fail-closed position
 - W72RSP shut-off for products containing large particulates (up to 1.25" (32 mm) diameter)
 - W72RS tank outlet version for safe separation between tank and servicing pipeline

Robust and Durable:

- Compression seat design on upper stem provides long seat life and reliability
- WCB's signature machined-from-bar bodies and components offer a robust and reliable valve solution
- Consistently thick body wall dimensions & laser welded port extensions minimize body distortion during manifolding & extreme fluid temperature changes
- Balanced design for resistance to hydraulic shock

Flexibility and Modularity:

- True-line mix body sizes and custom 45° or other angled ports available to match complicated pipe design
- Custom port lengths and center-to-center dimensions can match competitor and legacy series valves to provide easy drop-in replacements
- AL6XN alloy product zone parts available for corrosive products
- Various control top models available to fit customer needs: cost-effective CU4 full-featured, robust WCB control tops, or state-of-the-art Burkert 8681
- Choice of adapter options with stem flush, wiping stem seals, and steam sterilization

Low Cost Of Ownership With Easy Maintenance:

- Heavy-duty construction maximizes service life
- Minimum proprietary parts gives off-the-shelf availability and low price of most spares and tools
- Long life actuator is field-maintainable with finger-safe, caged springs and cartridge piston assemblies
- Simple, easy-to-maintain design is intuitive and does not require advanced mechanical skills

- Compressed air not required for disassembly, maintenance, or assembly procedures after removal from body
- With quick-disconnect pin connectors, control top can remain on valve during disassembly & maintenance. No added steps for removal or operator exposure to electrical controls.
- Adjustable seat clean travel allows users to optimize CIP flush going to drain
- External flush connections are stationary allowing hard piping of utilities and no pinch points

Domestic Manufacture, Local Support:

- Design, manufacturing, assembly, inventory, & customer service in Delavan, Wisconsin, USA
- Value-added and established distributor network

MATERIALS

Product Wetted: ASTM 316L (UNS-S31603); (DIN-1.4404)

Non-Product: ASTM 304 (UNS-S30400); (DIN-1.4301)

Seat: Compression Seal Upper Stem, Radial Seal Lower Stem

Elastomers: EPDM or FKM (Fluoroelastomer)

Internal Surface Finish: $\leq 32 \text{ Ra}$ ($\leq 0.8 \mu\text{m}$)
Other finishes available upon request.

PRESSURE RATINGS

OPERATING PRESSURE	
SIZE	MAXIMUM PRESSURE AT 70°F/21°C
1.5" - 4" (38 mm - 102 mm)	150 psi (10 bar)
6" (152 mm)	Consult Factory
2" - 4" Sch. 5 (51 mm - 102 mm) SCH. 5	150 psi (10 bar)
6" SCH. 5 (152 mm)	Consult Factory

Holding Pressure: 150 psi (10.3 bar)

Air Supply: 72 to 100 psi (5.2 to 6.9 bar)

Typical product applications

Beverage

- Beer
- Cider
- Fruit Drinks
- Liquid Sugar and Glucose
- Soft Drinks
- Wine
- Wort



Food

- Animal Oils
- Flavorings
- Pet Food
- Soups and Sauces
- Vegetable Juices
- Vegetable Oils
- Vinegars



Pharmaceutical and Toiletries

- Emulsions
- Extracts
- Lotions
- Perfumes
- WFI (Water for Injection)
- High Purity Water
- Pure Water



THEORY OF OPERATION:

Mix proof valves are used to safely and efficiently process two different fluids (typically product and CIP) through the valve simultaneously. The mix proof design has two seats which isolate the upper and lower pipe lines when the valve is in the fail-safe closed position. The atmospheric vent cavity in between the seats creates a path for any leakage should the seats fail as well as a drain for CIP solution during seat cleaning. An optional external flush is available to clean the area between the seats and the vent drain while the valve is closed during production.

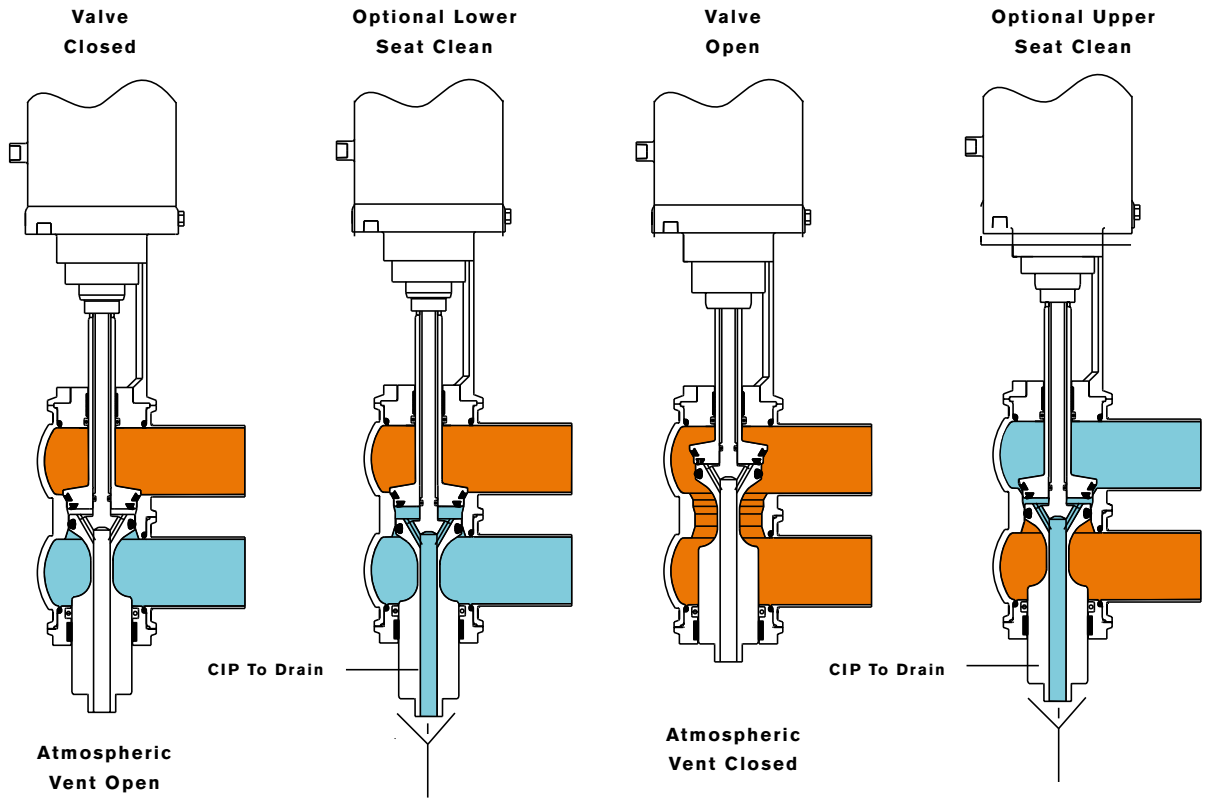

BODY CONFIGURATIONS

Shut-Off

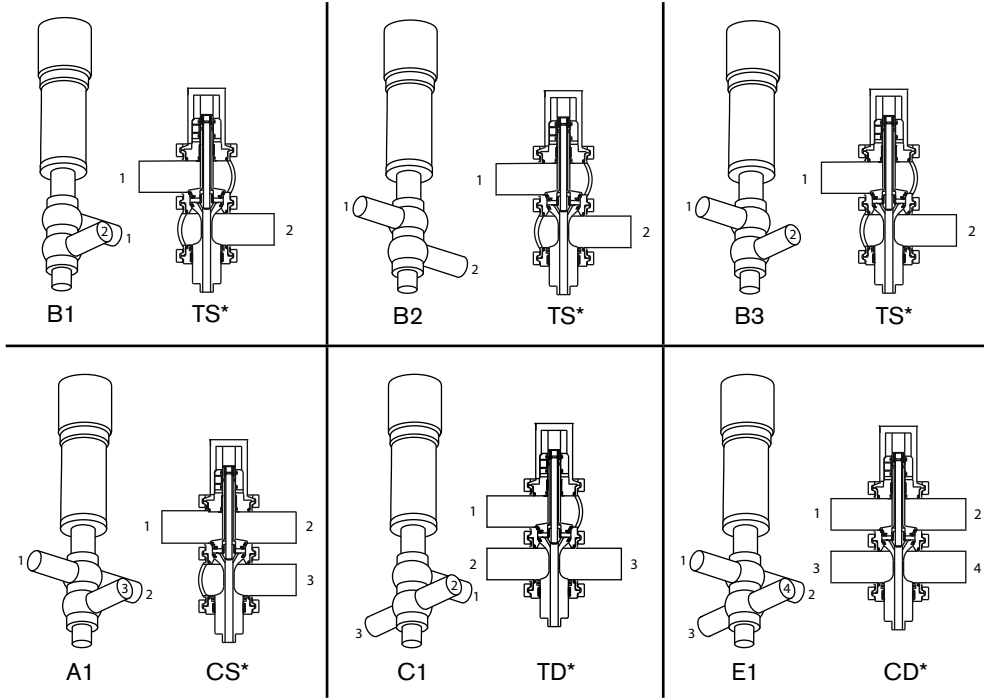

*Two Piece Clamped Bodies allow ports to be rotated in any direction.

Tank Outlet Valve

Two Piece Clamped Bodies*

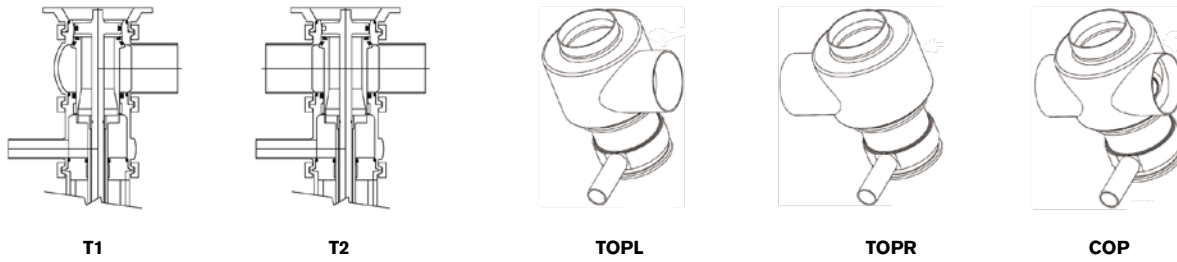

Control Tops

WAUKESHA CHERRY-BURRELL CONTROL TOP



New Set & Forget Control Top



FEATURES AND BENEFITS

- Transparent Control Top keeps all electrical components visible.
- Maintainable, designed with the user in mind, making assembly and troubleshooting worry free and easy.
- Waukesha Cherry-Burrell uses the industry's most widely recognized electrical components, so access to off the shelf replacement parts is easy, ensuring quick delivery and less down time.
- NEMA 4x (IP64)
- Stainless Steel Control Top Option

CONNECTOR OPTIONS

- S/O Cord Grip for hard wire (std)
- Quick Disconnect Pin Connector

INTERFACE OPTIONS

- AS-i Field Bus Card
- DeviceNet™ Field Bus Network Card

POSITION INDICATION

- Set & Forget Switch
- Inductive Proximity Switches 20-140V AC/DC, 2-Wire (Std)
- Microswitches 24VDC, 110VAC
- Intrinsically safe options 5-24VDC

SOLENOID VALVES

- 24V DC or 110V AC

CU4 CONTROL TOP



FEATURES AND BENEFITS

- Reliability and long service life - robust clamp connection, reinforced Stainless Steel air coupling threads to avoid air leakages, and water tight seals
- Cost-effective - simple design and limited options for basic control top functionality
- Ease of operation - contains manual override solenoids and adjustment screw to throttle air flow to actuator to ensure optimal opening and closing
- Clarity - clear and bright indication of valve position - 5 diodes in LED panel and convenient location
- Standardization - same control top used on various APV valve lines, offers common look and controls interface
- NEMA 6 (I67)

CONNECTOR OPTIONS

- S/O Cord Grip for hard wire (std)
- Quick Disconnect Pin Connector

INTERFACE OPTIONS

- AS-i Field Bus Card
- Profibus and DeviceNet™ (CU3)

POSITION INDICATION

- 2 internal feedback sensor switches for valve open/valve closed position detection

SOLENOID VALVES

- 24V DC or 110V AC
- Select 1 or 3 Solenoids

8681 CONTROL TOP



FEATURES AND BENEFITS

- Contact free position sensor including (3) programmable feedback signals
- Positions easily taught via intuitive push buttons or Autotune feature to ensure quick & easy set-up
- Ultra-bright 360° visual LED position indication with adjustable red, yellow, & green color assignments provide clarity from all points of view and avoid confusion
- Manual override and air throttle adjustable solenoids to assist start-up, maintenance, and troubleshooting
- Up to IP69K washdown rating available (IP65/67 as standard) for high washdown environments
- Built-in microcontroller tracks cycles and alerts operator when preventive maintenance is required
- Simple and robust stainless steel adapter & chemically resistant polycarbonate head
- Similar price as WCB control tops
- Supplied by industry leading Burkert Fluid Controls
- Class 1, Div 2 Explosion Proof option available

CONNECTOR OPTIONS

- S/O Cord Grip for hard wire (std)
- Quick Disconnect Pin Connector

INTERFACE OPTIONS

- AS-i Field Bus Card
- DeviceNet™ Field Bus Network Card

POSITION INDICATION

- (3) programmable position sensors in control top

SOLENOID VALVES

- 24V DC or 110V AC
- Manual override and air throttle adjustment
- Up to (3) available in control top

OPTIONS AND ACCESSORIES

Seat Options

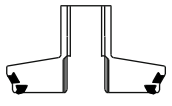
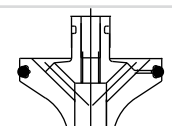
SEAT TYPE	MATERIAL	MAXIMUM TEMPERATURE
 <p>Tri Ring - Compression Seal (TR) Upper Stem</p>	EPDM or FKM (Fluoroelastomer)	Oper. 280°F (137°C) EPDM Steril. 275°F (135°C) EPDM Oper. 350°F (176°C) FKM Steril. FKM - Consult Factory
 <p>Radial - Seal Lower Stem</p>		

For higher temperature applications than those listed, please consult the factory.

ADAPTOR OPTIONS

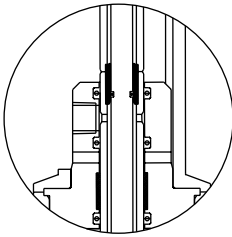

External Liquid Flush (vent cavity only)

1/4" NPT Flush Connection for cleaning the area between the seat and throughout the vent/drain cavity. Flush Pressure: 30 psig (2.1 bar) min. to 45 psi (3.1 bar) max. Flush access to vent/cavity only when valve is in closed position.

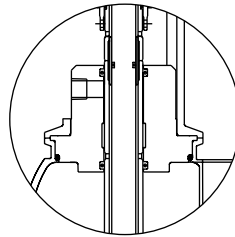

External Steam Barrier - Upper Stem

1/4" NPT Connection for steam trace of the upper stem o-ring and vent/drain cavity. Steam access to vent/drain cavity when valve is in open or closed position. Steam Pressure: Saturated steam 10 psi (.7 bar) max. Used with lower stem flush.

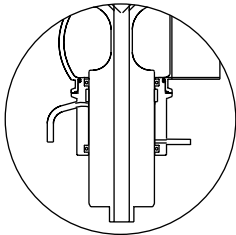
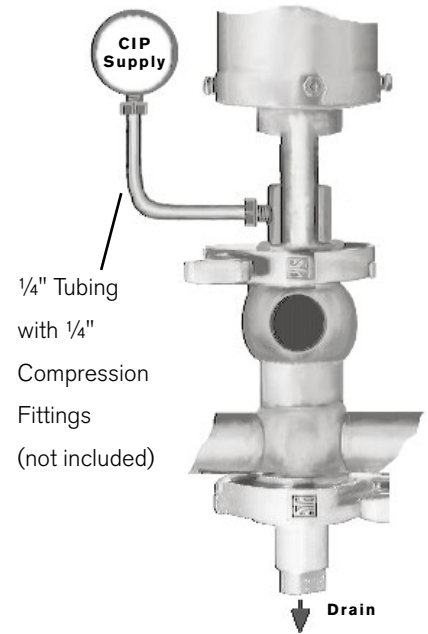

External Flush Lower Stem

1/4" Tube OD Connection for liquid or steam trace of the lower stem and o-ring. Flush Pressure: 30 psig (2.1 bar) min. to 45 psi (3.1 bar) max. Steam Pressure: Saturated steam 10 psi (.7 bar) max.

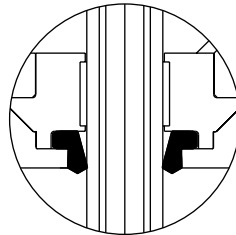

Wiping Stem Seal (Upper Stem)

Optional seal for both upper and lower stems, in place of standard o-ring available in EPDM or FKM (Fluoroelastomer).

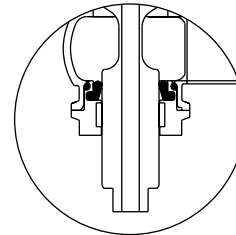

Wiping Stem Seal (Lower Stem)

PRODUCT DIMENSIONS

Shut-Off

VALVE SIZE INCH (mm)	A*	B	C	E*
1.5 (38)	16.6 (422)	2.63 (67)	4.0 (102)	3.5 (89)
2.0 (51)	17.0 (432)	3.13 (80)	4.0 (102)	3.9 (99)
2.5 (64)	17.4 (442)	3.63 (92)	4.0 (102)	4.6 (117)
3.0 (76)	17.6 (447)	4.13 (105)	4.0 (102)	4.9 (124)
4.0 (102)	18.0 (457)	5.13 (130)	6.0 (152)	5.8 (147)

* A & E dimensions shown without optional lower stem flush

Particulate

VALVE SIZE INCH (mm)	A*	B	C	E*
3.0 (76)	36.6 (930)	5.13 (130)	6.0 (152)	---
4.0 (102)	36.6 (930)	5.13 (130)	6.0 (152)	---

* A & E dimensions shown without optional lower stem flush

Tank Outlet

VALVE SIZE TUBE OD INCH (mm)	A	B	C	E
2.5 (64)	20.5 (521)	4.0 (102)	4.0 (102)	3.0 (76)
3.0 (76)	20.9 (531)	4.3 (109)	4.0 (102)	3.3 (82)
4.0 (102)	21.9 (556)	4.8 (122)	6.0 (152)	3.8 (97)

Control Top Dimensional Adder

CONTROL TOP	ADDER DIMENSION D INCH (mm)
WCB	6.25 (160)
8681	9.50 (241)
CU4	7.50 (190)

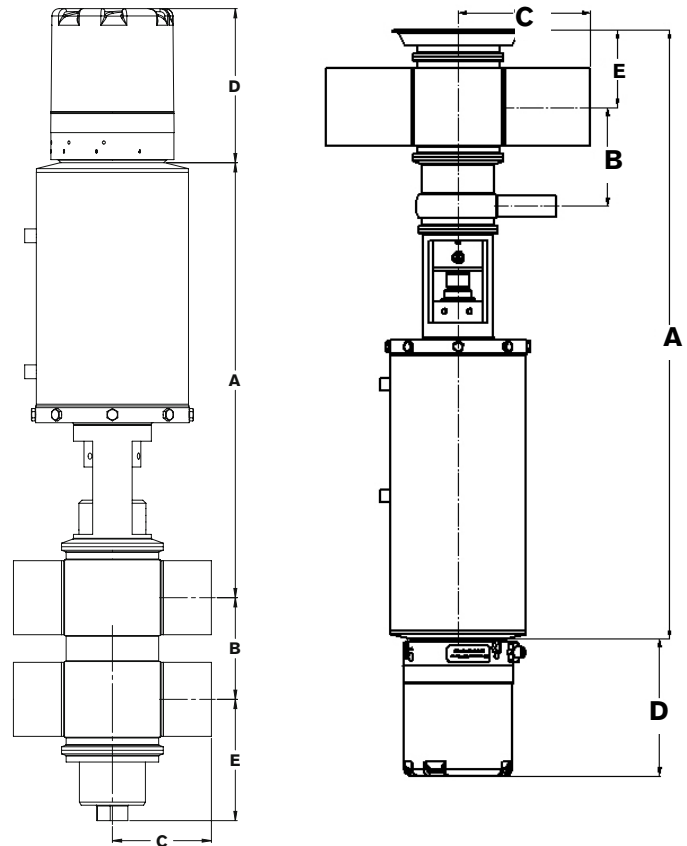

Note 1: A - dimension with seat lift actuator.

Note 2: A & E - Dimensions are with standard lower housing. For dimensions with lower flush housing, contact factory.

Note 3: F Dimension - Minimum clearance above valve required for valve removal.

Note 4: All dimensions in OD tube sizes. For schedule 5 size dimensions, see instruction manual 95-03091.

Air ports on actuator are 1/8" NPT. External flush/steam connection for upper stem & vent cavity is 1/4" NPT.

Lower stem flush connection is 1/4" Tube OD.

ADDITIONAL TECHNICAL DATA

Pressure Loss Curves - W72 Series CV

W72RS

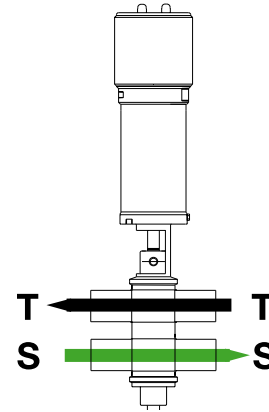
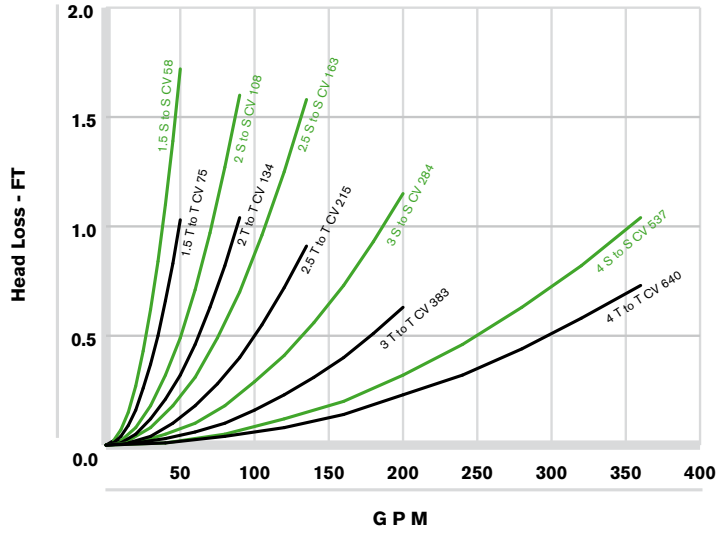

W72RSP

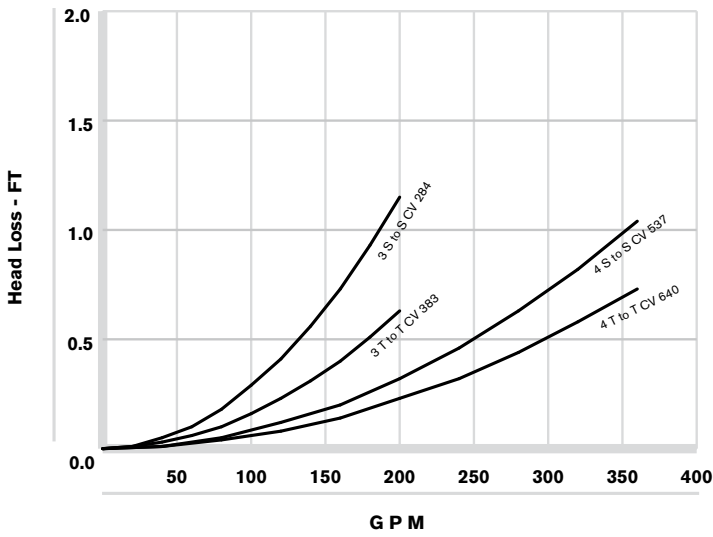

W72RS

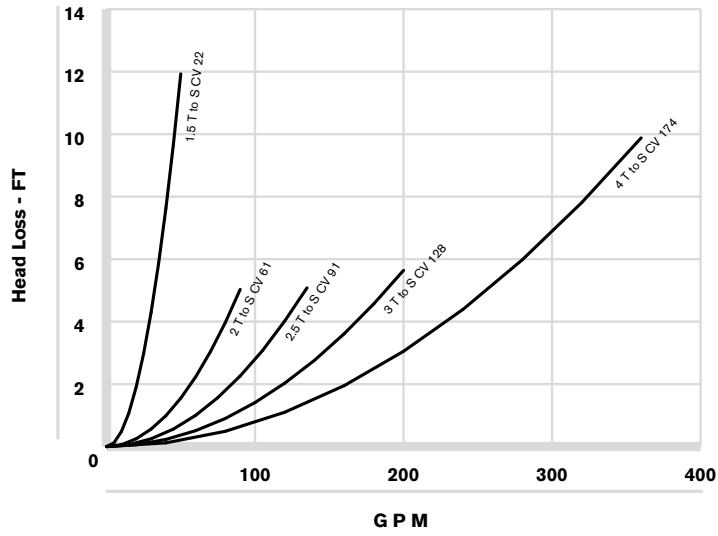

W72RSP

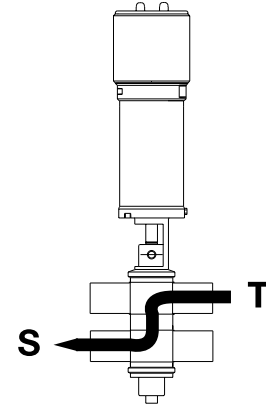
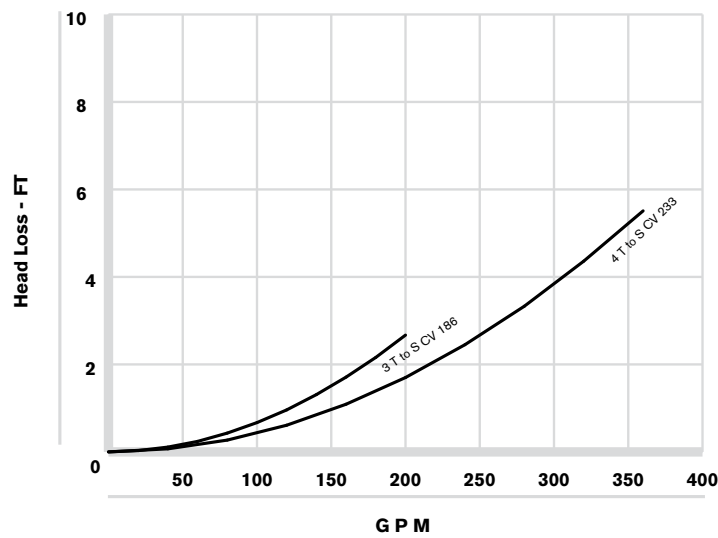

W72RS

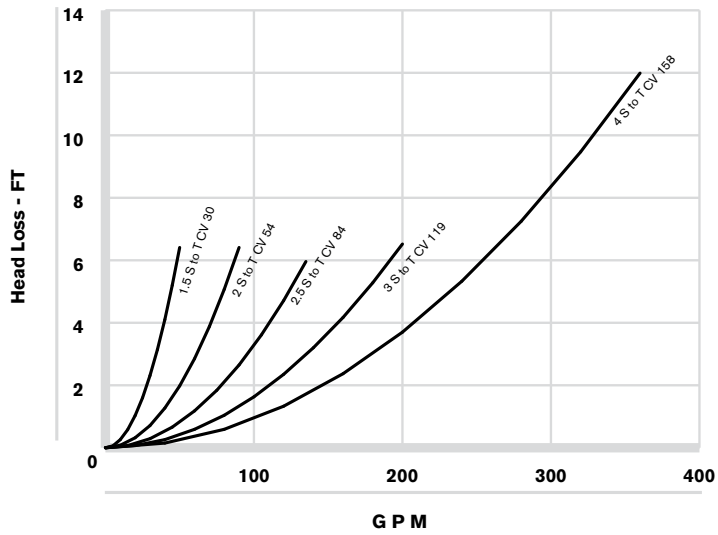

NOTE: For 6.0 OD and Schedule 5 sizes, please consult factory.

W72RSP

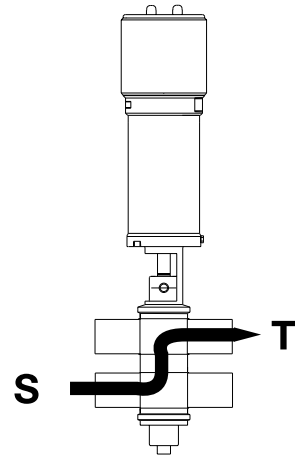
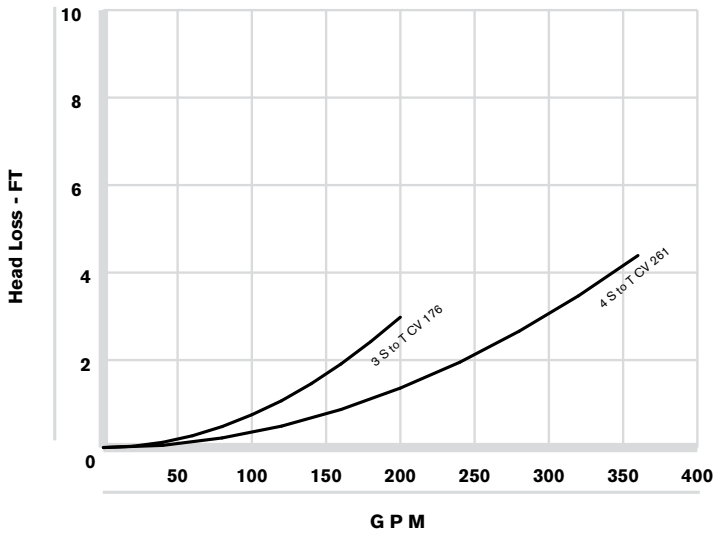

W72RS SERIES

**MINIMAL SPILL DOUBLE SEAT
MIX PROOF VALVES**

SPXFLOW

Based in Charlotte, North Carolina, SPX FLOW, Inc. (NYSE: FLOW) is a multi-industry manufacturing leader. For more information, please visit www.spxflow.com

SPX FLOW

611 Sugar Creek Road

Delavan, WI 53115

P: (262) 728-1900 or (800) 252-5200

E: wcb@spxflow.com

SPX FLOW, Inc. reserves the right to incorporate our latest design and material changes without notice or obligation.

Design features, materials of construction, dimensional data and certifications as described in this bulletin, are provided for your information only and should not be relied upon unless confirmed in writing. Please contact your local sales representative for product availability in your region. For more information visit www.spxflow.com.

The green "y" and "x" are trademarks of SPX FLOW, Inc.

WCB_Valves-Double-Seat-W72RS_DS-1221_US

Version 06/2020

COPYRIGHT © 2020 SPX FLOW, Inc.

Identification Number: DS-1221